

SWAGTRON®

USER MANUAL

Ver. 4.0 10/9/19

In order to continue serving our customers and providing the best products, our product information including our user manuals may receive updates from time to time. Please check our website for the latest user manuals and product materials.



EBIKE™ **EB-7**

Thank you for your purchase of the EB-7 eBike!

The EB-7 fuses a traditional pedal bike with all-electric power to create a green way to travel that helps you protect the environment while you enjoy it.

To ensure your safety and the safety of others, please read and follow the guidelines in this user manual carefully and thoroughly before and during riding.

If you have any questions regarding the EB-7, contact us at 1-844-299-0625 for further assistance.

Happy Riding!

-The SWAGTRON® Team

Table of Contents

PRODUCT SAFETY NOTICE	1	Section 5. Safe Riding Techniques & Tips.....	14
Section 1. General Information	3	5.1 Disposal at End-of-Life	14
1.1 About the SWAGTRON EB-7 eBike.....	3	Section 6. Maintenance	15
1.2 What's In the Box?	4	6.1 Tire Inflation.....	15
1.3 SWAGTRON EB-7 eBike Diagram.....	5	6.2 Cleaning.....	16
Section 2. Folding, Unfolding & Adjusting Your eBike....	6	6.3 Storage	16
2.1 Folding & Unfolding the Head	6	6.4 Transportation	16
2.2 Folding & Unfolding the Frame.....	7	Section 7. Specifications.....	17
2.3 Adjusting the Handlebars	7	One-Year Limited Hardware Warranty	18
2.5 Unfolding & Folding the Pedals.....	8		
Section 3. How to Use the Battery.....	9		
3.1 Charging Instructions.....	9		
3.2 Lock Instructions.....	11		
Section 4. How to Ride.....	12		
4.1 Riding Your eBike	12		
4.2 Buttons Information.....	12		
4.3 Display Information	13		
4.4 Display Brightness & Measurement Settings.....	13		

PRODUCT SAFETY NOTICE

The SWAGTRON EB-7 eBike has been designed with the utmost safety in mind for its riders. Extra precautions have been taken to protect the user from product hardware malfunctions through our meticulous design and engineering.

However, like any mode of transportation, the SWAGTRON EB-7 eBike has inherent hazards associated with its use (e.g.: losing control, falling off, or riding into hazardous situations). Be sure to read and follow all instructions and safety recommendations in this user manual prior to and when riding your eBike.

Before each ride, especially if you may travel a long distance, inspect your bike. First, check the tires for proper inflation and cracks on the walls of the tires. Keeping the tires properly inflated and maintained will help prevent flats and damage. Second, check all cables and cable housings for fraying, breaks, rust, or corrosion and replace if necessary. Lastly, inspect the brakes to make sure they are working properly. Additionally, check the brake pads for any damage as they will wear over time and eventually need replacement.

If a replacement of the brake pads or any other part is needed, please contact customer support for replacement service. In general, it is recommended to make sure all nuts and bolts are taut and properly fastened to prevent injury and unnecessary wear and tear on your eBike.

Maximum Weight	264 lbs / 120 kg
Maximum Throttle Speed	18.6 mph / 29.9 km/h
Range per Charge	Up to 15.5 mi / 25 km (gear 1)
Max Incline	25° (throttle only)

This device requires coordination, agility, and balance. Use your best judgement to determine if an individual can use the SWAGTRON EB-7 eBike safely.

SAFETY GEAR, CLOTHING, AND FOOTWEAR	<p>Please wear appropriate clothing and safety gear including shoes, kneepads, elbow pads and an ASTM F1492 approved helmet.</p> <p>Avoid wearing anything that can drape over or get caught into/under the wheels. Wear closed-toe, flat shoes to maintain flexibility and stability.</p>
MODIFICATIONS AND REPAIRS	<p>The SWAGTRON EB-7 eBike is a highly sophisticated electronics product that includes complex, technical circuitry. Attempting to repair or modify your eBike can void all warranties. Only authorized repair centers may service the SWAGTRON EB-7 eBike.</p>
OBEY LOCAL LAWS AND REGULATIONS	<p>Always check and adhere to local laws regarding personal transportation devices, including pedestrian laws.</p> <p>The eBike is considered a motor vehicle and should not be ridden after consuming alcohol or drugs.</p>

By riding the SWAGTRON EB-7 eBike, the user acknowledges and accepts personal responsibility of all risks associated with the use of the SWAGTRON EB-7 eBike, which may include, but are not limited to, muscle injuries, broken bones, lacerations, or serious injury that may be sustained while using the SWAGTRON EB-7 eBike.

Section 1. General Information

Before operating your eBike, please read all instructions. This manual will guide you through the functions, usage, and proper care of your EB-7. If you have any questions or cannot find the information you need in the manual, please contact your place of purchase or our customer service at 1-844-299-0625. Before contacting customer service, please have your purchase information ready as this may be needed during the call.

When reading this manual, note these icons:

- ⚠ Notes with this icon **MUST** be read, understood, and obeyed to prevent injury or damage, etc.
- ℹ Notes with this icon include relevant information.

1.1 About the SWAGTRON EB-7 eBike

The EB-7 Electric Bike is a compact, zero-emissions, personal transportation device that feels like a bike but rides like a moped! It's environmentally-friendly and uses only the highest quality components and industry-leading safety features.

- Eco-friendly with zero emissions
- Folds at the frame, stem, and pedals
- Offers powered speeds up to 18.6 mph
- Rechargeable, portable, and reliable



1.2 What's In the Box?

- 1 x SWAGTRON EB-7 eBike
- 1 x Charging Cable & Adapter
- 2 x Keys
- 1 x User Manual

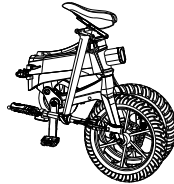

SWAGTRON EB-7 Electric Bike x 1

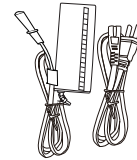

Charging Cable & Adapter x 1

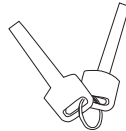

Keys x 2



User Manual x 1

1.3 SWAGTRON EB-7 eBike Diagram

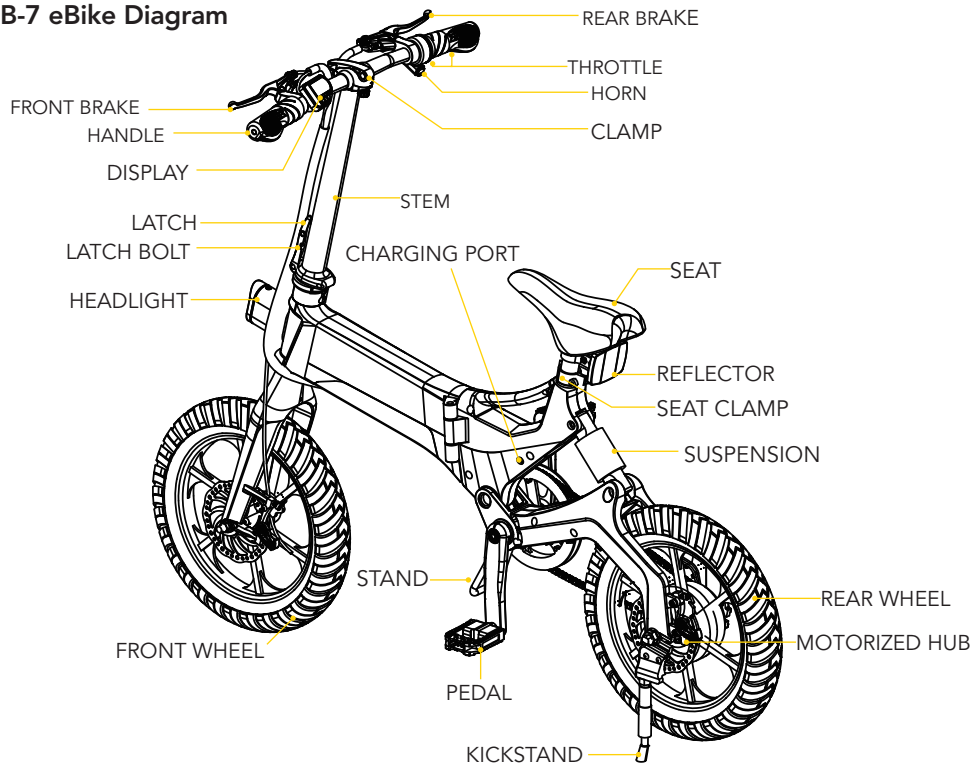

Section 2. Folding, Unfolding & Adjusting Your eBike

2.1 Folding & Unfolding the Head

 Be careful not to position your fingers between the latch and the stem. Doing so may result in injury.

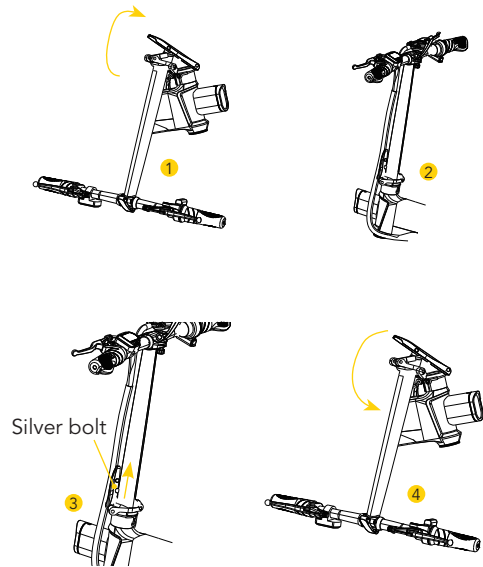

To Unfold (1 & 2):

Step 1. Pull the handlebar stem upright.

Step 2. Fold the latch up to close it. It will snap into place.

To Fold (3 & 4):

Step 1. Locate the silver bolt in the side of the latch and pull it up.

Step 2. While holding the bolt up, use your other hand to unfold the latch by pulling it down away from the stem. There is a notch on the other side of the latch to make this easier.

Step 3. With the latch undone, fold the stem down.

2.2 Folding & Unfolding the Frame

To Unfold the Frame

Step 1. Unfold the rear wheel / section and keep your eBike upright with the kickstand. While holding the latch lock up, push the latch closed. Make sure the hook end of the latch is secure and let the latch lock turn down into the latch to lock everything in place. (5).

To Fold the Frame

While holding the latch lock up, use your other hand to open the latch by pulling it away from the frame (5). Fold the rear wheel / section towards the other wheel and use the stand under the frame as needed.

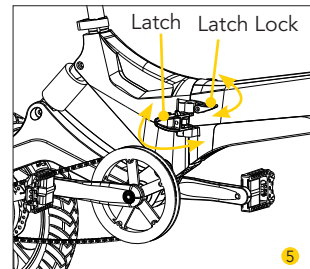

2.3 Adjusting the Handlebars

Unfold the clamp, then rotate and adjust the direction of the handlebars to a comfortable position (6). Secure the handlebars by flipping the clamp closed (7).

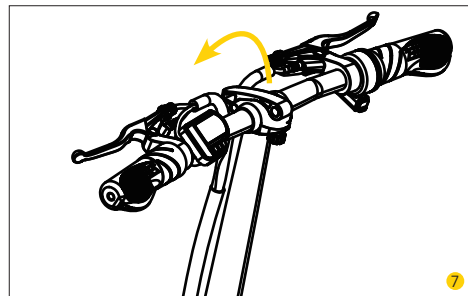
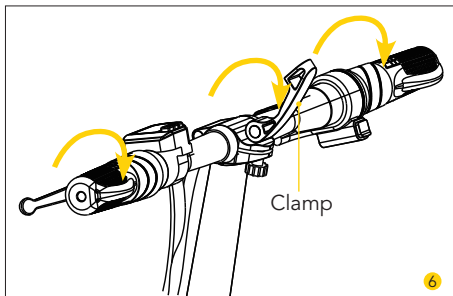

2.4 Adjusting the Seat Height

For better pedaling, safety, and overall comfort, positioning the seat at the right height is key. The rider's leg length is used to determine the seat's position. During pedaling, your hips should remain level and your legs shouldn't over-extend. To determine the right seat height, sit on the eBike with one pedal at its lowest point and place the ball of your foot on the pedal. If your knee bends slightly at this position, the seat is at the right height. Additionally, when placing your heel on the pedal, your leg should be nearly straight.

First, open the clamp under the seat post. Pull the seat up or push it down to adjust height. Check to make sure the seat post is fully inserted into the frame and the head of the seat is parallel with the frame. Lastly, close the clamp to secure the seat in place (8).

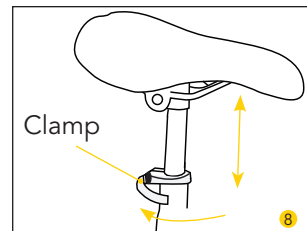

2.5 Unfolding & Folding the Pedals

Holding the crank arm vertical, fold or unfold the pedal. Repeat with the other pedal as needed (9).

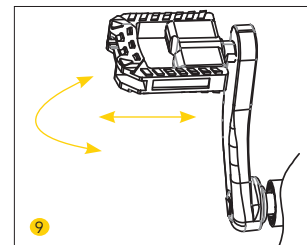

Section 3. How to Use the Battery

3.1 Charging Instructions

 Charge the eBike before using it.

Step 1. Make sure the bike is turned off and connect the charger's cables and adapter if needed.

Step 2. Plug the charger into a wall outlet (100V-240V) then plug the other end into the charging port. Remove the cap as needed.

Step 3. Allow 3~4 hours' time for charging. The charging adapter's light will turn red during charging and then turn green once charging is complete. Disconnect all cables once charging is finished.

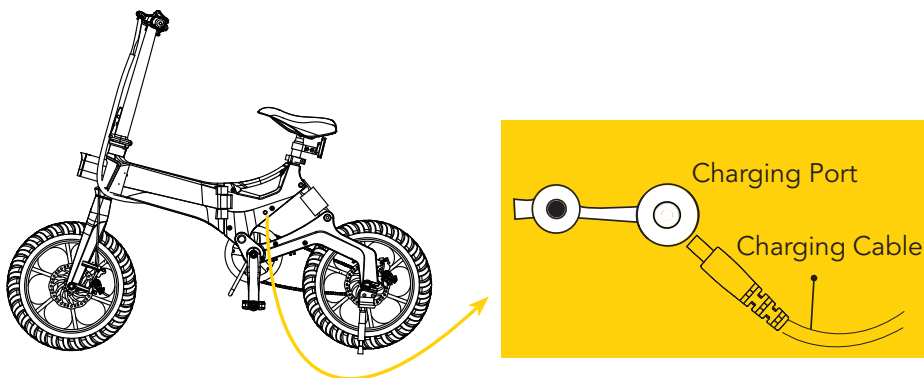



- Fully charge the battery before your first use, this may take up to 4 hours.
- Perform periodic visual inspection of the battery ports and charging cables.
- Keep your charging environment clean and dry at all times.
- If the charging port is damp or has any liquid on it, do not charge your eBike.
- In order for the battery to operate at maximum efficiency, avoid charging your eBike in extremely hot or extremely cold environments.



- DO NOT, under any circumstances, use the bike while it is charging or connected to the charger.
- The charging time is 3~4 hours. Charging longer than that may affect battery life and/or performance. If the charging adapter's light doesn't turn on, it may not be fully connected. Check that it is securely connected to the wall and to the bike.
- Use only the charger provided with your EB-7. If you have lost or misplaced your charger, contact customer support to obtain a replacement.

3.2 Lock Instructions

For your convenience, the EB-7's battery can be removed and locked as needed. Fold the bike first before using the lock and/or removing the battery.

Step 1. Use the included keys to unlock the battery via the keyhole inside the folded frame (8). To unlock the battery, insert the key, and turn it to the unlock (🔓) position.

Step 2. With the key inserted into the keyhole, lift the handle and use it to pull the battery out (9).

Step 3. To reinstall the battery, reinsert it into the frame. Turn the key to the locked (🔒) position.

🔑 Remember to lock the battery and remove the key before unfolding and/or riding the bike.

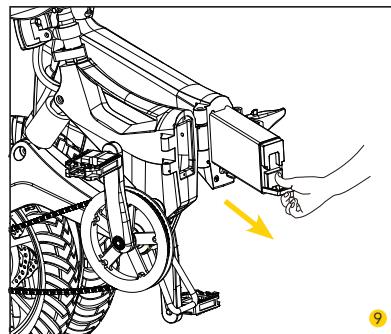
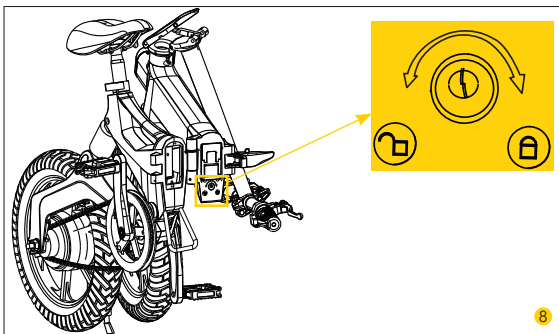

Section 4. How to Ride

4.1 Riding Your eBike



- Start your eBike by pressing and holding the power button ~2s, or ride it with your feet directly. Power-assisted mode will be on whenever power is on.
- Quick-press the power button to cycle between TRIP, VOL, TI, and ODO on-screen.
- Quick-press the **+** and **-** buttons to switch between modes 1, 2, and 3.
- Move forward by twisting the throttle.
- To stop, release the throttle, then squeeze the front and rear brakes to slow the front and rear wheels down.
- Use the horn and headlight to alert pedestrians and other riders of your presence.

4.2 Buttons Information

The EB-7 eBike's display features several different elements.

⏻ : Press and hold for ~2 seconds to turn the eBike on/off. Quick-press to cycle between TRIP, VOL, TI, and ODO on-screen.

+ : Quick-press to switch between modes 1, 2, and 3. Press and hold for ~2 seconds to turn the headlight on/off.

- : Quick-press to switch modes 1, 2, and 3.



4.3 Display Information

 This icon indicates cruise control's status i.e. on/off. Maintain speed for ~7 seconds to use this feature. Brake to turn it off.

 This icon indicates the headlight's status i.e. on/off.

 These numbers indicate the current speed. Readings are measured in mph or km/h.

TRIP: These numbers show distance data for a single trip. Data is automatically cleared when the bike is powered off.

ODO: These numbers show odometer data i.e. cumulative distance from 0 to 6213 mi. Data accumulates in increments of 0.63 mi. If a single trip is less than 0.63 mi, it is not included in the total mileage. When data exceeds the maximum (6213 mi), the odometer will automatically reset to zero.

TI: These numbers show time data for a single trip.

VOL: These numbers show current voltage information.

Battery Level: This icon indicates how much battery life you have left.

MODE 1, 2, 3: Displays the current speed mode. Each gear has different speed. Gear 1's max. is 11.3 mph, Gear 2's is 13.7 mph, and Gear 3's is 18.6 mph.

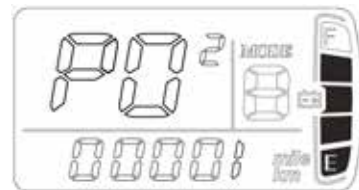
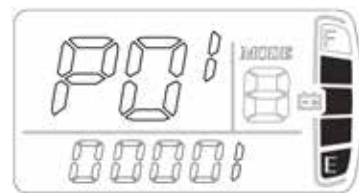
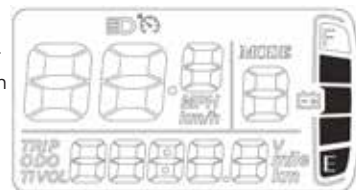

4.4 Display Brightness & Measurement Settings

Press and hold **+** and **-** buttons for ~2s to enter the display setting screen.

To adjust brightness, press the  button to enter P0¹ screen, then use **+** and **-** buttons to adjust the brightness of the display's backlight.

To switch speed measurement (mph/mile or km/h/km). Press the  button to enter P0² screen, then use **+** and **-** buttons to set the display to the desired measurement type.

Section 5. Safe Riding Techniques & Tips

Consider the following techniques and info to help ensure you have a safe, fun riding experience. Before riding, always check to make sure your brakes are working properly.

- ▲ • Make sure your feet are always on the pedals. Taking your feet off the pedals while riding is dangerous.
 - Remember to remain seated when using the eBike's cruise control function.
 - Make sure the battery is fully charged especially if you plan to travel long distances.
 - For your own safety and the safety of others, ride only at speeds you are comfortable with and be ready to stop at any time.
 - When riding near others, keep a safe distance from fellow riders to avoid collisions.
 - Pay attention to your surroundings. Your eyes are your best tools for safely avoiding obstacles and unsafe surfaces.
 - Ride in open spaces and flat areas. Avoid slopes or high traffic areas until you're familiar with riding.
 - Do not ride at high speeds, on uneven terrain, in inclement weather, or otherwise unsafe conditions.
 - Never use the eBike to do anything that may cause personal injury or property damage.
 - Do not attempt to carry passengers or heavy items. The bike can only support the weight of one person at a time. Do not exceed the weight limit.
 - Only ride the eBike where permitted. You **MUST** comply with local laws and give way to pedestrians.

DO NOT USE THE EBIKE TO PERFORM DANGEROUS MANEUVERS. FAILURE TO EXERCISE GOOD JUDGEMENT AND HEED THE ABOVE WARNINGS INCREASES THE RISK OF SERIOUS INJURY OR, IN VERY RARE CASES, DEATH. USE WITH APPROPRIATE CAUTION AND SERIOUS ATTENTION TO SAFE OPERATION.

5.1 Disposal at End-of-Life

This product must not be disposed of by incineration, landfilling, or mixing with household trash. Improper disposal of the battery contained within this product may result in the battery heating up, rupturing, or igniting which may cause serious injury. The substances contained inside the battery present chemical risks to the environment. The recommended disposal for any SWAGTRON product at its end-of-life is to dispose of the entire unit at or through an e-waste recycling center, program, or facility.

Local regulations and laws pertaining to the recycling and disposal of lithium-ion batteries and/or products containing them will vary according to country, state, and local governments. You must check laws and regulations corresponding to where you live in order to properly dispose of the battery and/or unit. It is the user's responsibility to dispose of their waste equipment properly with accordance with local regulations and laws.

For additional information about where you should drop off your batteries and electrical or electronic waste, please contact your local or regional waste-management office, your household waste disposal service, or your point-of-sale.

Section 6. Maintenance

- ⚠ • Do not perform any kind of maintenance while the eBike is charging.
- Attempting to repair or modify your eBike can void all warranties. Only authorized repair centers may service the eBike.

If you need assistance, please contact customer service.

6.1 Tire Inflation

🔧 You will need a pressure gauge, a standard bicycle pump to inflate the EB-7 eBike's tires.

Step 1. Ensure the eBike is powered off and stable, so it doesn't move during inflation.

Step 2. Visually inspect the tires for damage, scuff, or puncture marks. If the tire is damaged, DO NOT INFLATE IT. Contact customer service immediately.

Step 3. Find the valve located on the inside of the wheel and remove the cap.

Step 4. Use a standard bicycle pump to pump air to the tires slowly.

Step 5. Use the pressure gauge periodically to check PSI.

Step 6. When the tire reaches 40-65 PSI/2.8-4.5BAR, stop inflating and replace the valve cap.

Step 7. Repeat with other tire.

-  Any PSI marking on the tires indicates a maximum. DO NOT inflate the front tire to this value, only inflate it to 65 PSI as directed above.
- Underinflation is strongly recommended if you intend to ride outdoors in temperatures above 90°F degrees. Bring the EB-7 eBike indoors and deflate the tires to 58.5 PSI. If the PSI is too high and the tire are exposed to excessively high temperatures, riding outdoors may cause serious damage to the tire including but not limited to stretching and/or rupturing.

6.2 Cleaning

Proper cleaning of your eBike can guarantee a longer lifespan and a smooth riding experience.

- Wipe the outer body of your eBike with a soft, dry microfiber cloth.
- Check around the wheels and ensure there is no blockage, the eBike's design allows for easy wheel maintenance.
- The eBike meets IPX4 water-resistance, meaning it can withstand splashes; however, do not submerge the eBike in water.
- Do not let water and liquids get into the eBike's electric parts or battery.

6.3 Storage

Below are some tips to consider when storing your SWAGTRON EB-7 eBike.

- Before storing, fully charge the eBike to prevent battery over-discharge due to non-use.
- If storing the eBike for more than one month, discharge and recharge the battery at least once a month.
- Cover the eBike to keep dust out. Do not store in a dusty environment as this may cause damage over time.

6.4 Transportation

Before moving, lifting, or otherwise transporting the eBike, turn it off. The eBike weighs approximately 42.3 lbs. If you are unsure of your ability to lift this much weight, ask someone for help.

Lithium-ion batteries are considered hazardous materials; therefore, transportation is governed by federal, state, and local laws.

International law prohibits the shipping of bare lithium-ion batteries. If you are shipping your SWAGTRON EB-7 eBike, you must ship it with the battery installed.

Section 7. Specifications

Item	Parameters
Model Name	EB-7
Net Weight	42.3 lbs / 19.2 kg
Unfolded Dimensions	52.8 x 22 x 42.1 in. / 1340 x 560 x 1070mm
Folded Dimensions	29.5 x 16.5 x 26 in. / 750 x 420 x 660mm
Max Incline	25°
Maximum Load	264.5 lbs / 120 kg
Maximum Throttle Speed	18.6 mph / 29.9 km/h
Range Per Charge	Up to 15.5 miles (gear 1)
Battery Voltage	36V 5.2 Ah
Charging Voltage	100V - 240V / 50 - 60Hz / 42V 1.5A 
Horn Voltage	36V 0.5W
Wheel Size	16" Front / Rear
Wheel Inflation	40-65 PSI/2.8-4.5BAR
Charging Time	3~4 Hours
Water Resistance	IPX4
Warranty	1 Year Limited

One-Year Limited Hardware Warranty

Your SWAGTRON® EB7 E-Bike ("Product") includes a One-Year Limited Hardware Warranty ("Warranty"). The Warranty covers product defects in materials and workmanship under normal use. This Warranty is limited to residents of the United States and Canada only and is available only to original purchasers. This Warranty gives you specific legal rights and you may also have other rights which vary from state to state.

This Warranty starts on the date of your purchase and lasts for one (1) year (the "Warranty Period"). The Warranty Period is not extended if the Product is repaired or replaced. We may change the availability of this limited warranty at our discretion, but any changes will not be retroactive.

Warranty services are provided by SWAGTRON®. If a hardware defect arises and a valid claim is received within the Warranty Period, at its option and to the extent permitted by law, SWAGTRON® will: (1) repair the hardware defect by using new or refurbished parts that are equivalent to new in performance and reliability; or (2) exchange the Product with a product that is new or refurbished which is substantially equivalent to the original product. This Warranty is for one (1) replacement only of like-items and does not cover items out of production if the product is no longer made or stocked. This Warranty is not assignable or transferable. The original purchaser may call SWAGTRON's toll-free number at 1-844-299-0625 for service request.

When a product or part is exchanged, any replacement item becomes your property and the replaced item becomes SWAGTRON's property. This warranty only covers technical hardware defectiveness during the warranty period and under normal use conditions. SWAGTRON® does not warrant uninterrupted or error-free operation of this Product.

Return shipping shall only be provided for Products dead on arrival ("DOA") within thirty (30) days of purchase only. All other returns/repairs shall require payment of shipping cost at discounted rate to be determined as follows:

SWAGTRON® E-bikes shall be Twenty Dollars (\$20)**

**shipping prices are subject to change without further notice.

This Warranty does not cover any damage due to: (a) transportation; (b) storage; (c) improper use; (d) failure to follow the product instructions or to perform any preventive maintenance; (e) modifications; (f) unauthorized repair; (g) normal wear and tear (including but not limited to wearables and other consumable parts such as tires); or (h) external causes such as accidents, abuse, or other actions or events beyond our reasonable control.

Important: Do not disassemble the Product. Disassembling the Product will void this Warranty. Only SWAGTRON® or a party expressly authorized by SWAGTRON® should perform service on this Product.

DISCLAIMER OF WARRANTY: THE REMEDIES DESCRIBED ABOVE ARE YOUR SOLE AND EXCLUSIVE REMEDIES AND OUR ENTIRE LIABILITY FOR ANY BREACH OF THIS LIMITED WARRANTY. OUR LIABILITY SHALL UNDER NO CIRCUMSTANCES EXCEED THE ACTUAL AMOUNT PAID BY YOU FOR THE DEFECTIVE PRODUCT, NOR SHALL WE UNDER ANY CIRCUMSTANCES BE LIABLE FOR ANY CONSEQUENTIAL, INCIDENTAL, SPECIAL OR PUNITIVE DAMAGES OR LOSSES, WHETHER DIRECT OR INDIRECT.

SOME STATES DO NOT ALLOW THE EXCLUSION OR LIMITATION OF INCIDENTAL OR CONSEQUENTIAL DAMAGES, SO THE ABOVE LIMITATION OR EXCLUSION MAY NOT APPLY TO YOU.

SWAGTRON®

COPYRIGHT © 2019 SWAGTRON. ALL RIGHTS RESERVED.